

Applicable Model

R20B

Drawing Title

Decorative Panel

Drawing Unit

mm

Drawing Scale

Not to scale

**DRAFT
SUBJECT TO
CHANGE**

Last Revised

Oct 09, 2023

Drawing Version

V1.0

Page

1 of 3

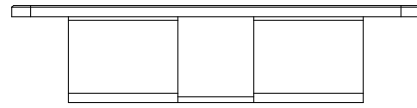

5 TOP VIEW

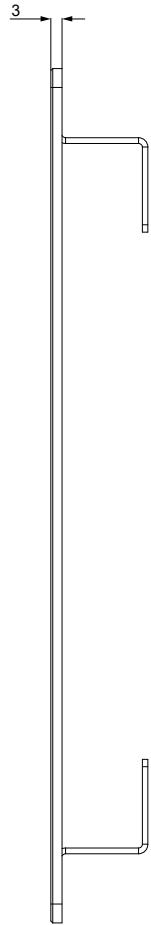

2 RIGHT VIEW

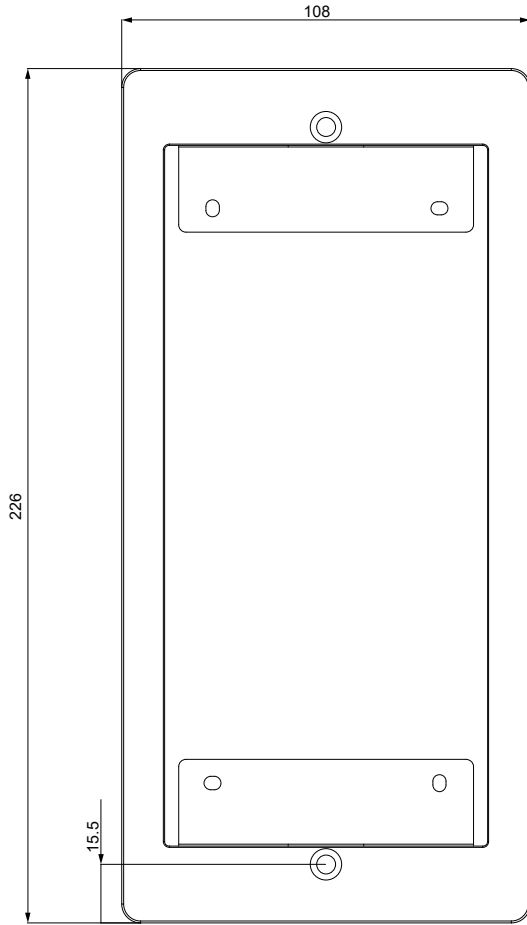

1 FRONT VIEW

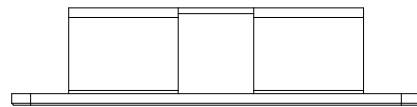

6 BOTTOM VIEW

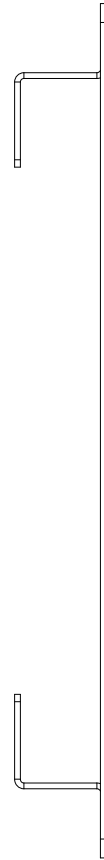

3 LEFT VIEW

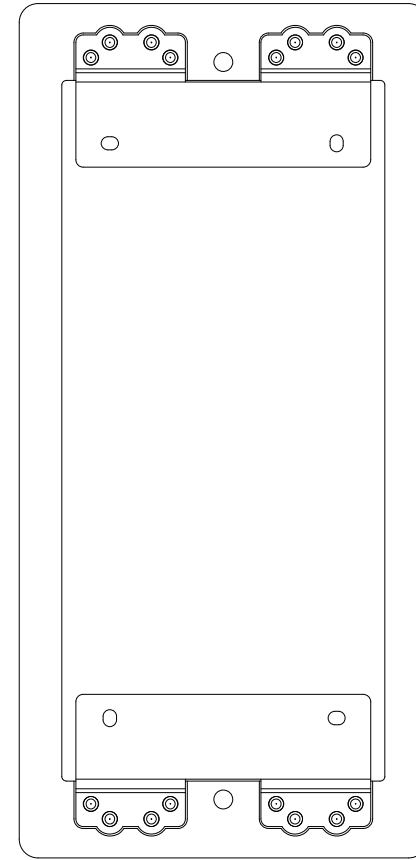

4 BACK VIEW

Applicable Model

R20B

Drawing Title

Flush Mounting Box

Drawing Unit

mm

Drawing Scale

Not to scale

DRAFT
SUBJECT TO
CHANGE

Last Revised

Oct 09,2023

Drawing Version

V1.0

Page

2 of 3

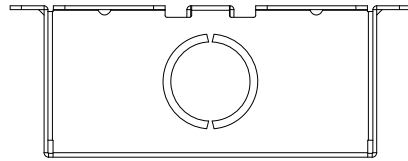

5 TOP VIEW

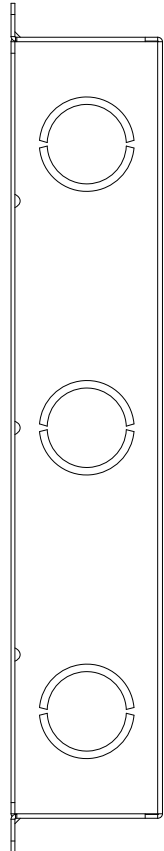

2 RIGHT VIEW

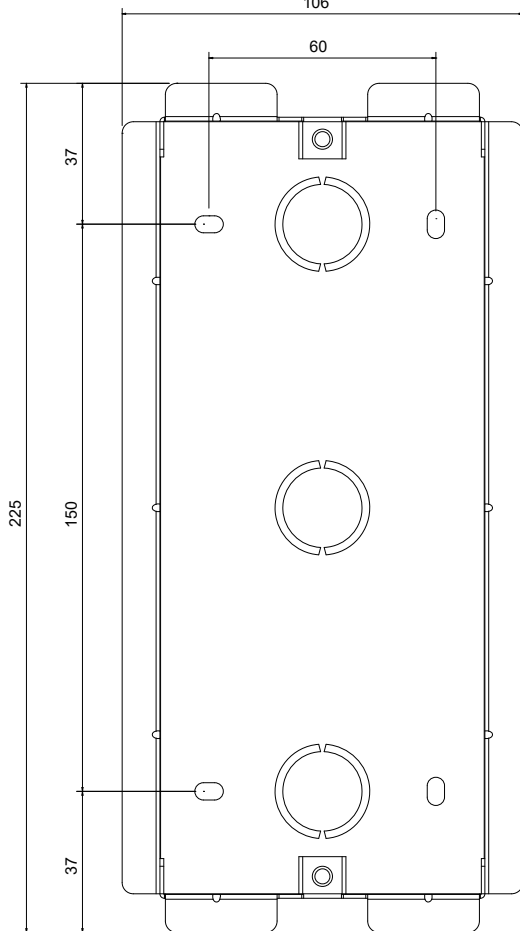

1 FRONT VIEW

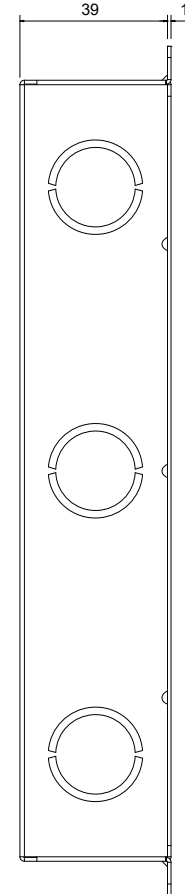

3 LEFT VIEW

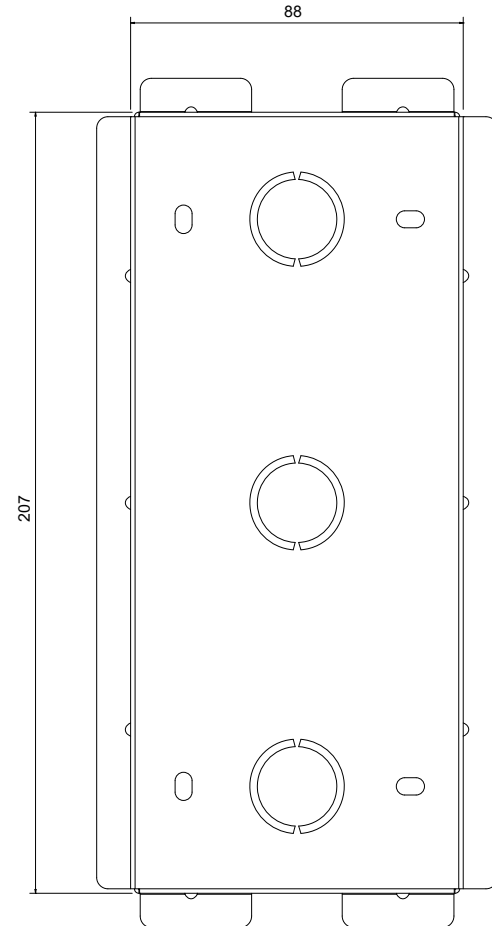

4 BACK VIEW

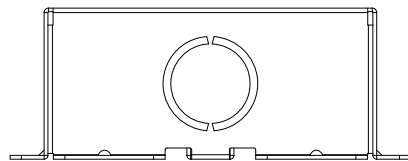

6 BOTTOM VIEW

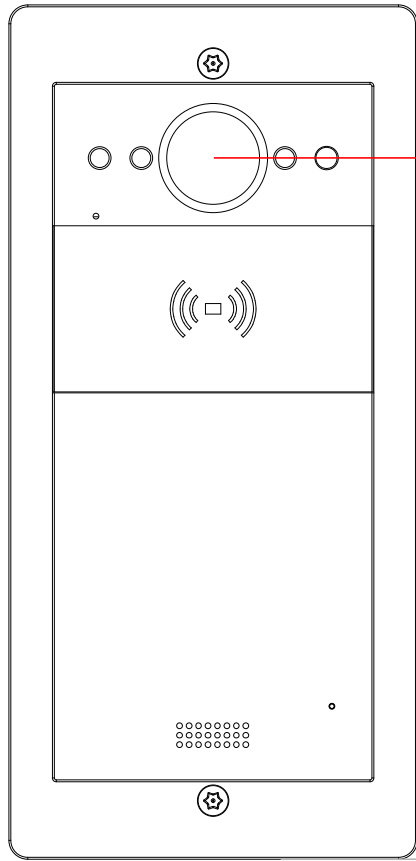

1 INTERCOM PANEL FRONT VIEW

1214.5mm TO BOTTOM OF BRACKET

1400mm TO CENTER OF CAMERA

ADA Compliance Requirement

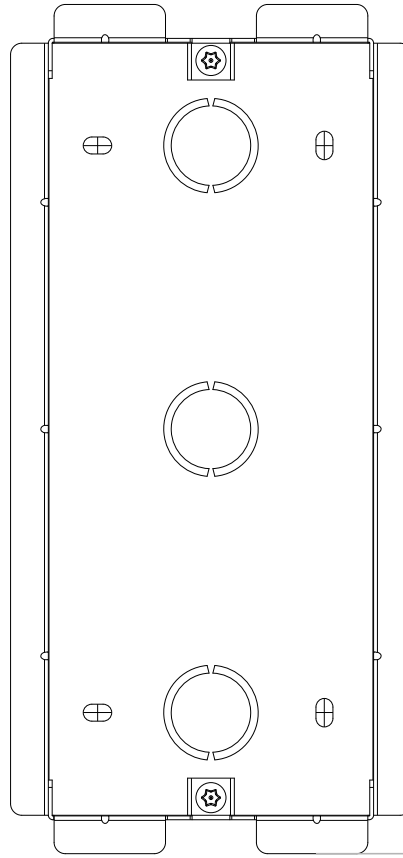
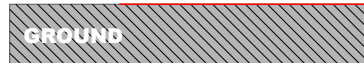

2 FRONT VIEW: FLUSHING MOUNTING BOX PLACEMENT

1215mm TO BOTTOM OF BRACKET

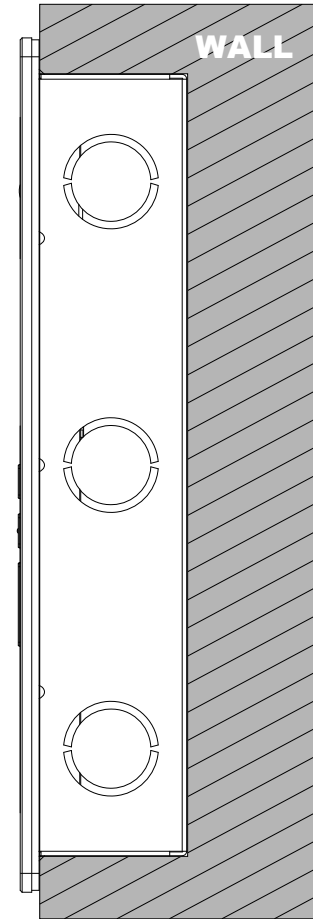
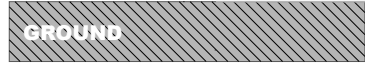

3 SIDE VIEW: INTERCOM PANEL IN WALL

Applicable Model

R20BX2

Drawing Title

Placement

Drawing Unit

mm

Drawing Scale

Not to scale

**DRAFT
SUBJECT TO
CHANGE**

Last Revised

Oct 09,2023

Drawing Version

V1.0

Page

3 of 3